



INSTALLATION GUIDE

Laundry Jet Plus

April 2022

Version 4.0 Revision 0.1

*Rev 8 Units for Use with **ISlide Ports***

*Laundry Jet
2001 Challenger Avenue
Oroville, CA 95965*



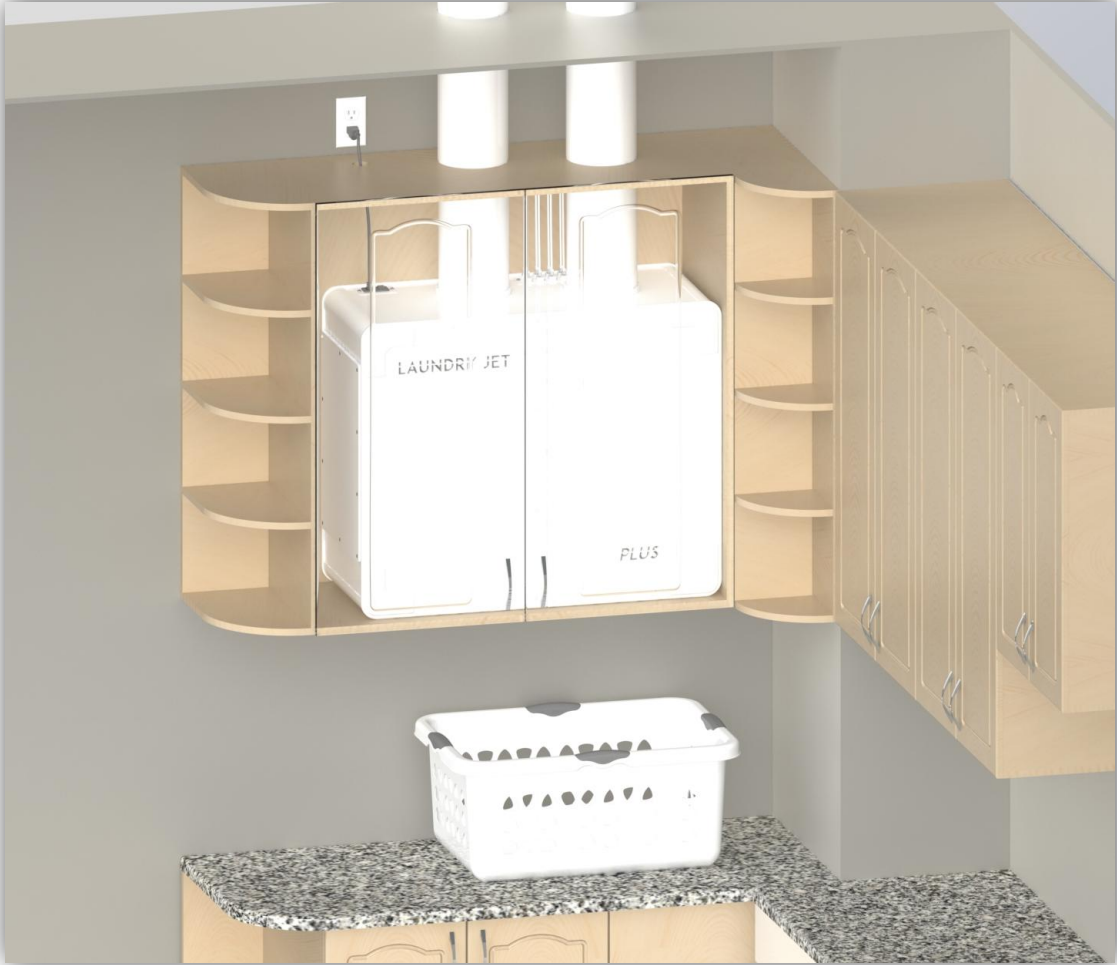

Document Revisions

Date	Version Number	Document Changes
4/12/2017	1.0 Rev 0.1	Plus Jet Pack Installation Guide - Rev 3 Units
7/21/2017	1.0 Rev 0.2	Plus Jet Pack Installation Guide - Rev 3 Units
5/4/2020	2.1 Rev 1.0	Plus Jet Pack Installation Guide - Rev 4 Units
6/17/2021	2.1 Rev 2.0	Plus Jet Pack Installation Guide - Rev 6 Units
12/21/2021	3.0 Rev 0.1	Plus Jet Pack Installation Guide - Rev 7 Units
4/12/2022	4.0 Rev 0.1	Plus Jet Pack Installation Guide - Rev 8 Units

Table of Contents

1	Introduction	5
2	Contents	6
3	Pipe Installation Overview	7-10
	3 - Components & Tools	7
	3.1 - Pipe Installation Standards	8
	3.2 - Port Drop Installation	19
	3.3 - Port 90 Installation	10
	3.4 - Plus Jet Pack Pipe Drop	11
4	ISlide Port Installation	12-15
	4 - Components & Tools	12
	4.1 - Port 90 Mount Bracket	13
	4.2 - ISlide Sheetrock Template	14
	4.3 - ISlide Port Installation	15
5	Plus Jet Pack Installation	16-28
	5 - Components & Tools	16
	5.1 - Jet Pack Installation	17-28
6	Warranty	29
7	Engineering Prints	30-33



1 Introduction

The Laundry Jet installation is comprised of three elements:

- Laundry Jet Ports mounted in bedrooms, dressing rooms or bathrooms
- The laundry room Wall mounted or Cabinet Mount Vacuum Unit
- The PVC pipe and fittings that connect the ports to the laundry room through the attic space

Vacuum Laundry Pipe

Laundry Jet specifies 6" SDR35 White Solvent Weld PVC pipe and fittings. This piping is light weight to make install quick and easy.

PVC piping is designed to have a smooth transition in between fittings and connections which ensures that clothing, bedding and towels will travel smoothly to the laundry room.

Pipe & Fittings

6" SDR35 White Solvent Weld PVC pipe 10' x 6"

All Fittings are 6" SDR35 White Solvent Weld

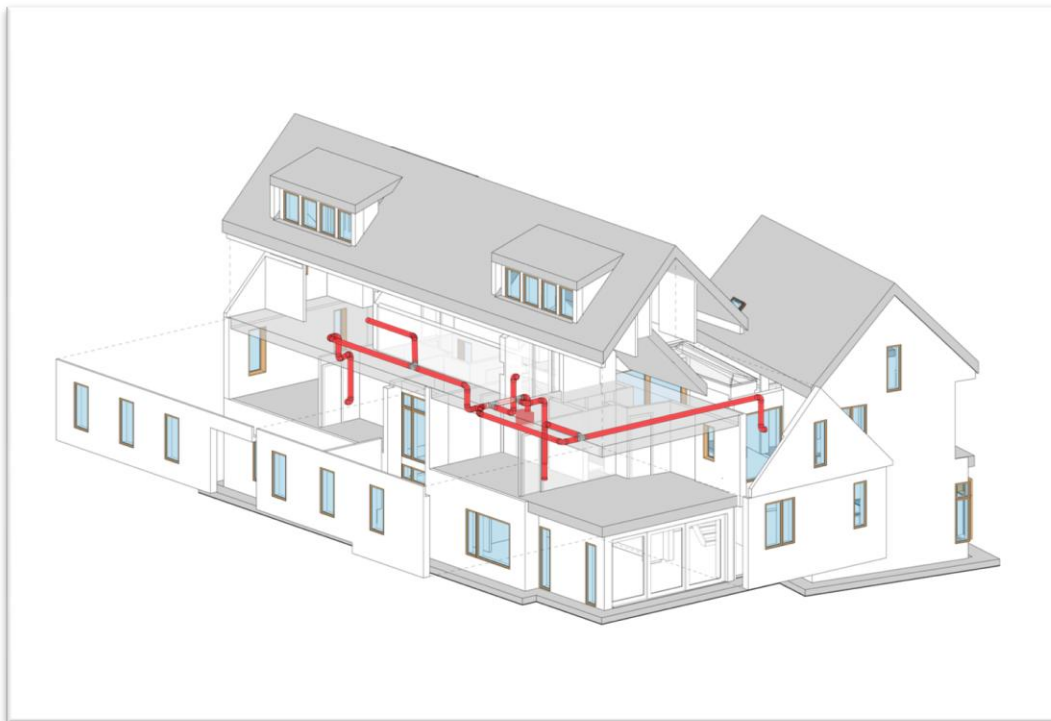

2 Contents

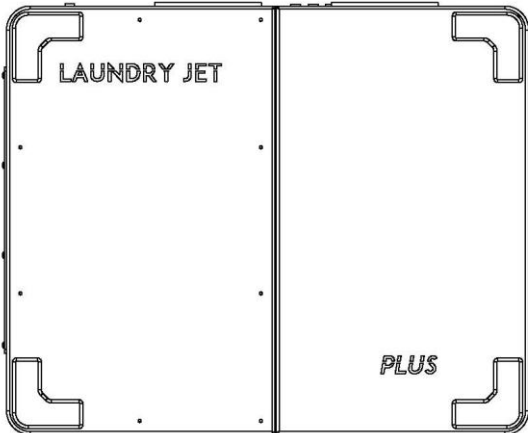

Laundry Jet Plus Jet Pack

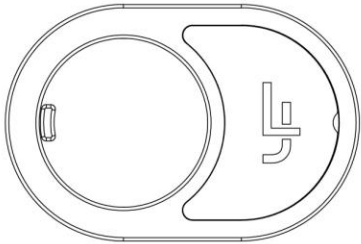

ISlide Port

Pipe Components

All Fittings are 6" SDR35 White Solvent Weld

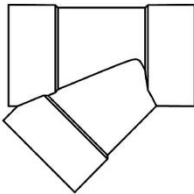

6 Inch Wye

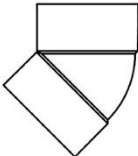

6 Inch 45° Elbow



6 Inch Coupler



6 Inch Cleanout

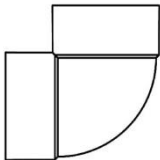

6 Inch 90°

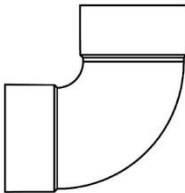

6 Inch Swept 90°

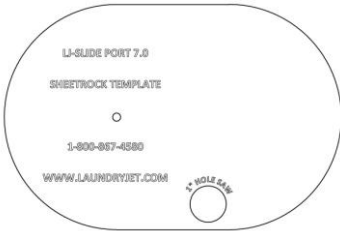

ISlide Sheetrock Template

3 Pipe Installation Overview

Components

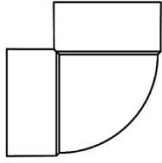

Port 90 Assembly Adapter

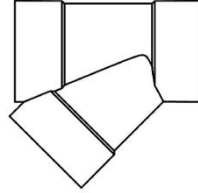

6 Inch Wye

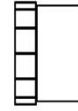

6 Inch Cleanout

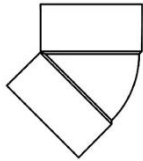

6 Inch 45° Elbow



ISlide Sheetrock Template



Cable Bundle

Tools



Cordless Drill

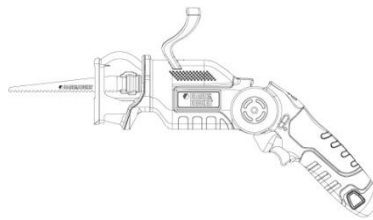

Sawzall

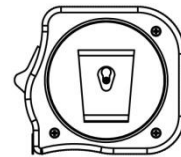

Tape Measure

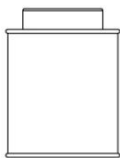

Clear 2 Part PVC Glue



1" Wood Screw



Plumber's Metal Strapping Tape



3.1 Pipe Installation Overview

Pipe Installation Standards

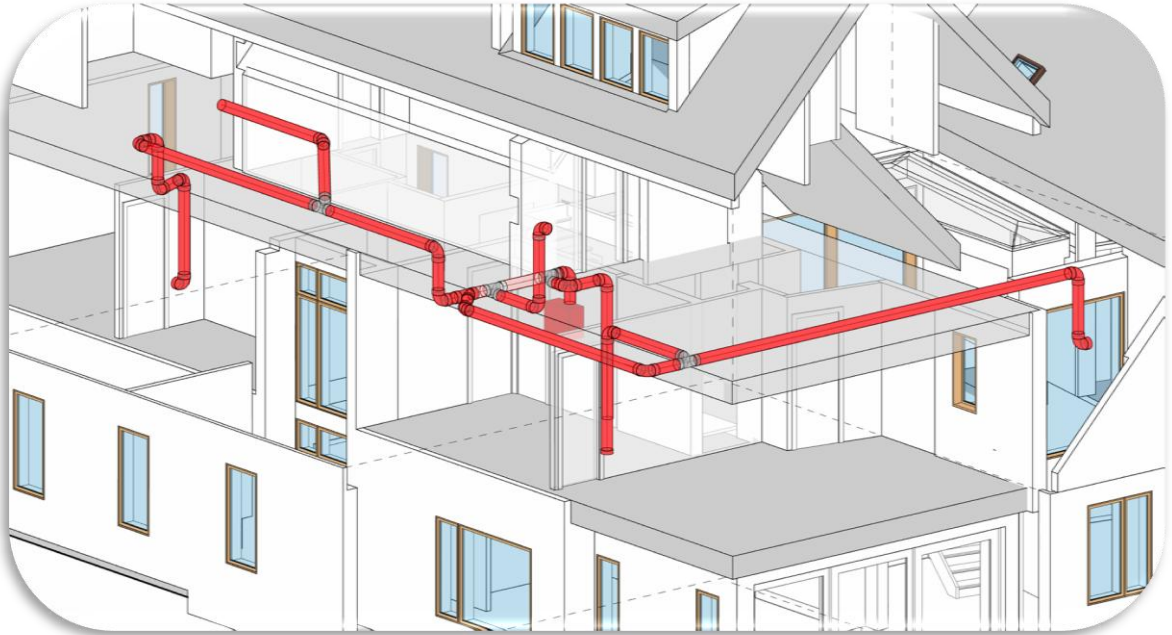

Required Piping Installation Standards

- All joints must use a minimum entry angle of 45 degrees with a break distance of 18 Inches (460 MM). See Image below.
- Pipe cuts must be straight and de burred before seating.
- Pipe must be completely seated in fitting connections.
- Seal all joints using standard PVC glue. Connections must be glued around 360 degrees to ensure maximum system performance.
- System must be strapped with “plumbers tape” (or equivalent) every 6 feet. Port 90 must be strapped and secured prior to Port installation.
- Install Cleanout ports every 50 feet on angled runs. Straight trunk lines can run up to 100 feet with cleanouts at either end.

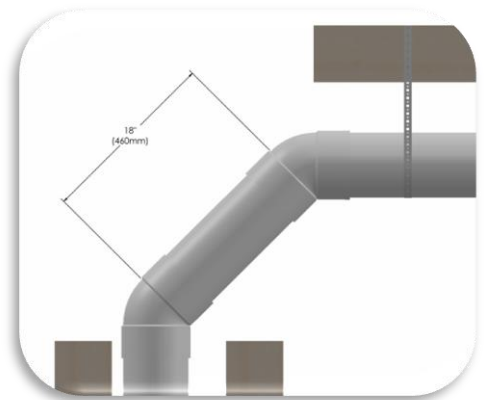

3.2 Pipe Installation Overview

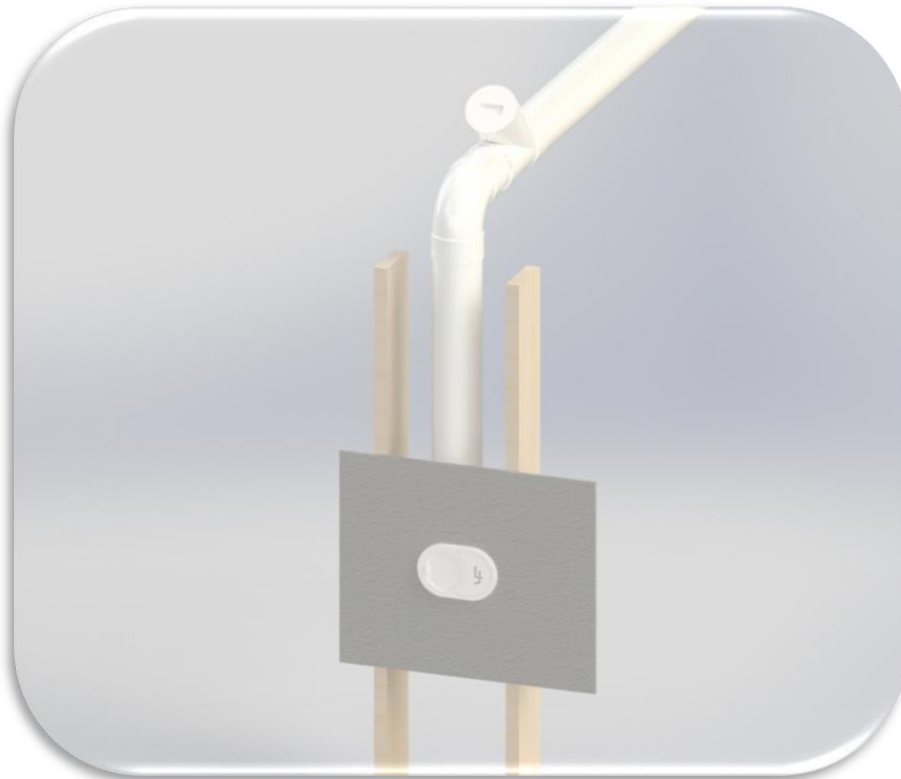

Port Drop Installation

- Mount port 90 using the Port 90 Mount Bracket. See Page 11 for Port 90 Installation. Use a standard SDR 6" Swept 90 for your Port Drop Installation. Block and strap drop line at midway point



3.3 Pipe Installation Overview



Port 90 Installation

- Port 90 must be installed with front face of Port 90 flush with the finished face of interior wall.
- Port 90 must be installed on a plum horizontal port drop line.
- Use the Port 90 Mount Bracket to align and secure the Port 90 to the frame (unless a remodel)



Pipe Mount Bracket



1" Wood Screw

3.4 Pipe Installation Overview

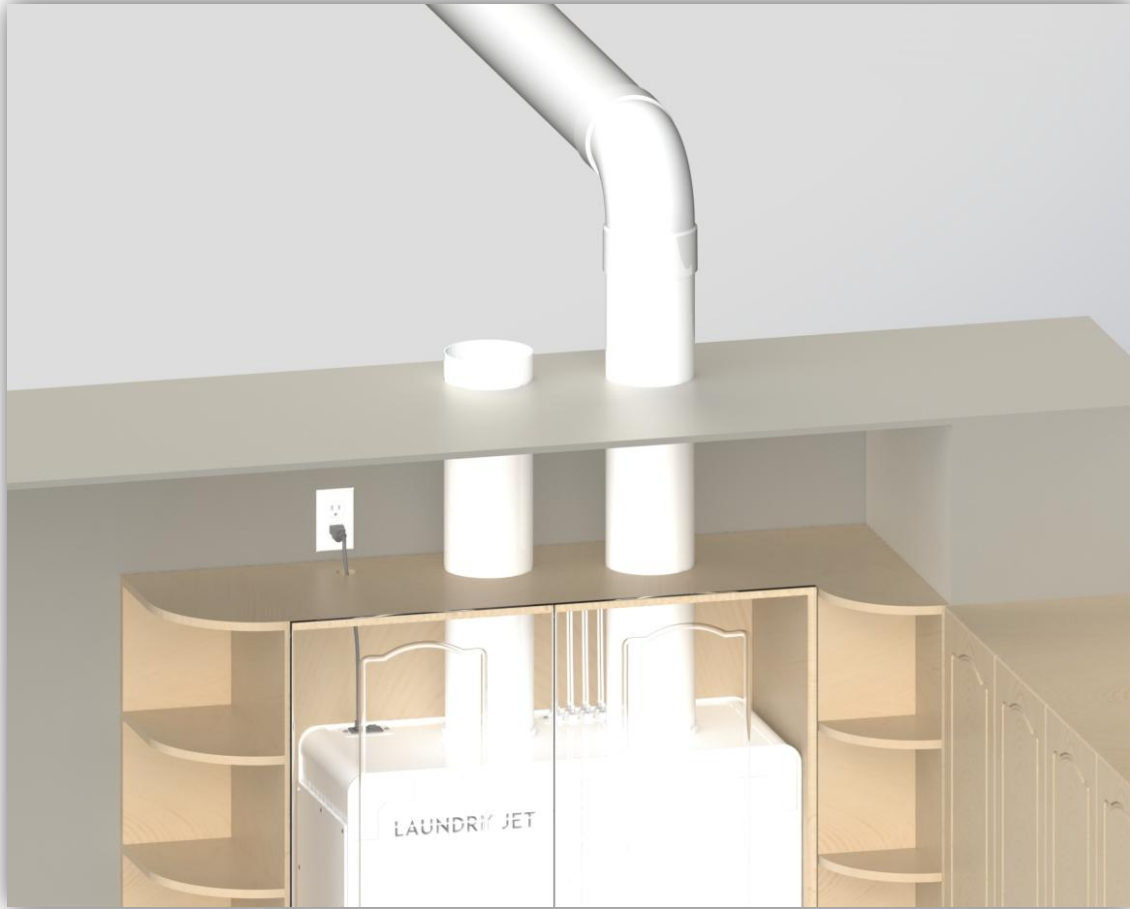

Plus Jet Pack Pipe Drop

- Install a standard swept 90 drop to each port using a swept 90 elbow.
- Strap pipe at attic to ceiling transition.

4 ISlide Port Installation

Components

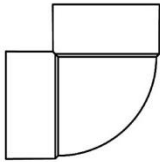

Port 90

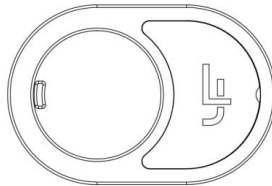

ISlide Port



ISlide Sheetrock Template



Pipe Mount Bracket



1" Wood Screw

Tools



Stud Finder

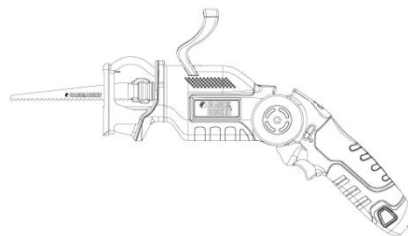

Sawzall



Screw Driver

4.1 Step 1 - Port 90 Mount Bracket



Port 90 Mount Bracket

- Use the Port 90 Mount Bracket to align and secure the Port 90 to the frame
- Set Port height
- Attach 2 pipe clamps
- Set elevation screws
- **Do not install Ports behind doors**



4.2 Step 2 - ISlide Sheetrock Template

Sheetrock Template

- Install sheetrock over the Port 90 Mount Bracket
- Trim around outside edge of the Port 90 and remove material

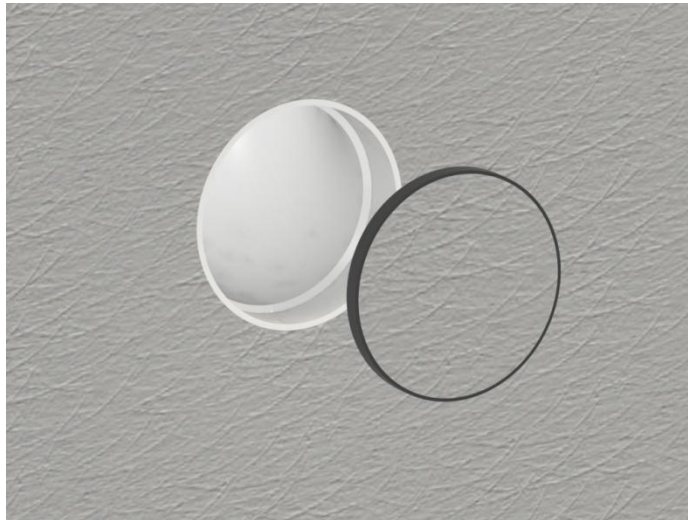

- Position the round portion on the back of the template into the Port 90
- Using a level use the top horizontal edge to level the template
- Trace around the inside of the 1" diameter hole in the template
- Using a 1" hole saw, cut a hole through the sheetrock



4.3 Step 3 - ISlide Port Assembly



ISlide Port Assembly

- Connect RJ45 male connector to female connector on back of port
- Remove the front logo plate and position the Port into place
- Align Port for final adjustment using a level
- Attach port using (3) sheetrock screws. For proper door function, the screws must be flush.
- Reattach the front logo plate



5 Plus Jet Pack Installation

Components

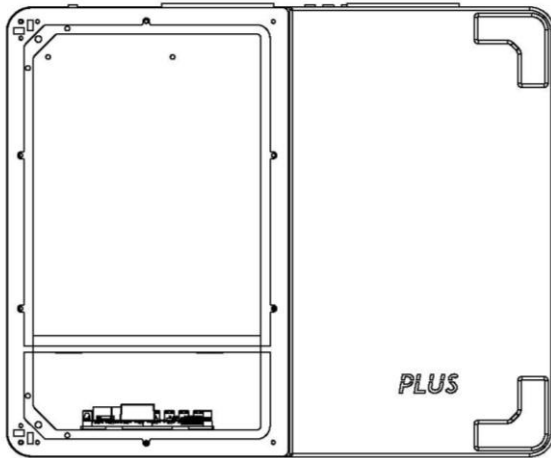

Plus Jet Pack Housing

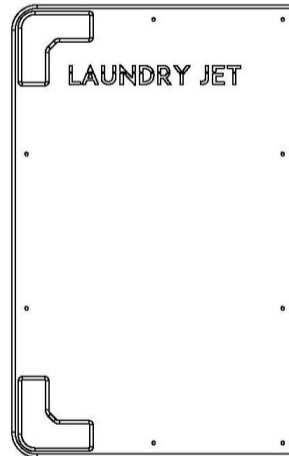

Plus Jet Pack Front Panel

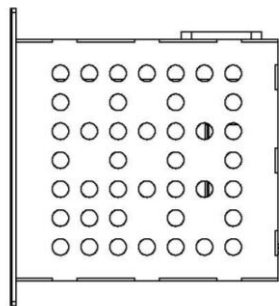

Plus Jet Pack Blower Pod



4" Square Connector

Tools



Cordless Drill



Stud Finder

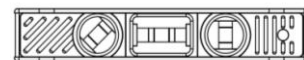

Level

5.1 Plus Jet Pack Installation

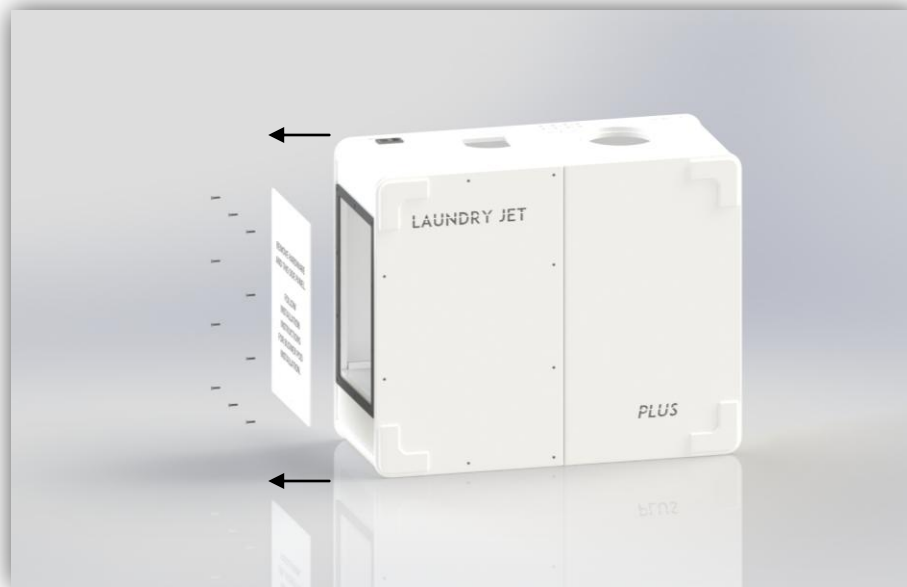

Blower Pod Installation

The Plus Blower Pod must be installed prior to installation of the unit in the cabinet.

- Remove the ten 10-32 screws from the left side of the unit and remove temporary cardboard/wooden stabilizing plate.
- Using a flathead screw driver, carefully remove the two left side magnetic cover plates. Remove the two 1/4-20 screws and the twelve 6-32 screws. Remove the front panel of the Plus Unit.

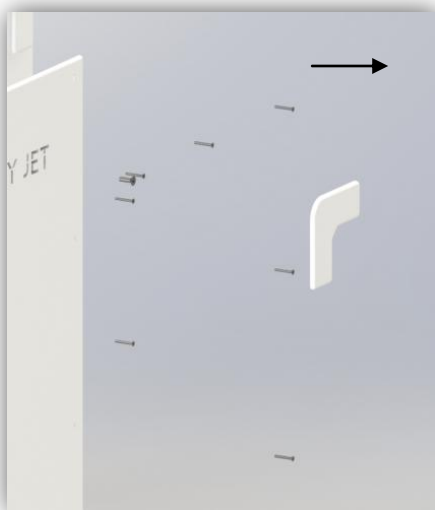

5.2 Plus Jet Pack Installation

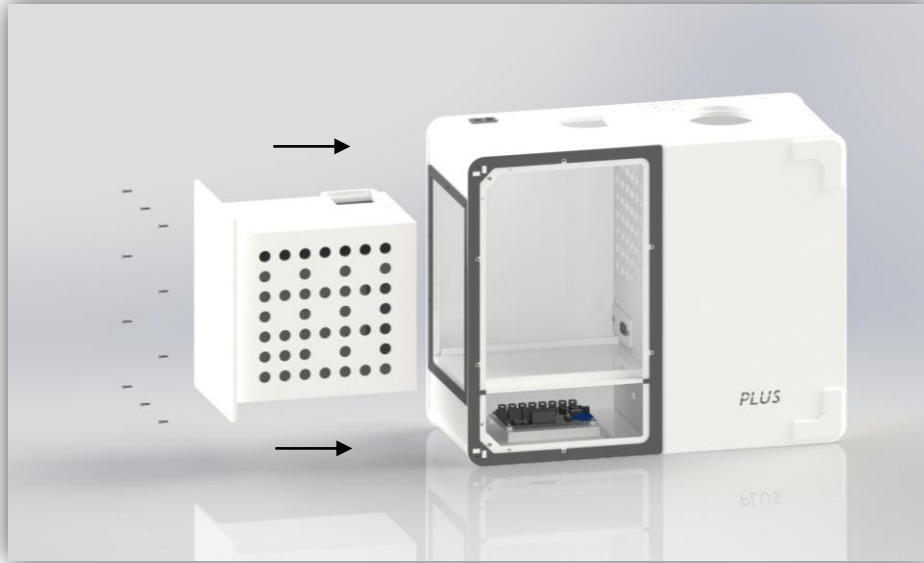

Blower Pod Installation

- Align and position the blower pod between guide rails and slide into the unit until fully seated. Reinstall the ten 10-32 screws.
- Install the 4" Square Connector thru the square cutout in the unit, and into the square flange of the Blower Pod. Ensure that the connector is fully seated and flush with the top face of the blower pod.

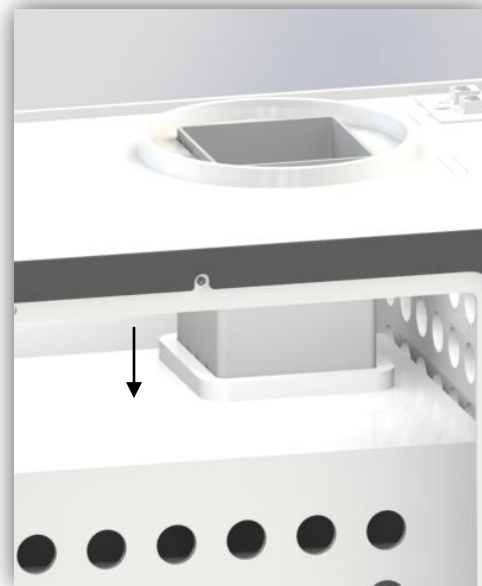
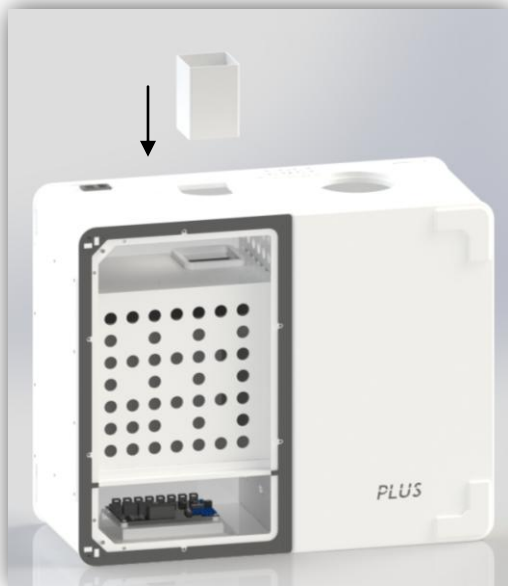

5.3 Plus Jet Pack Installation

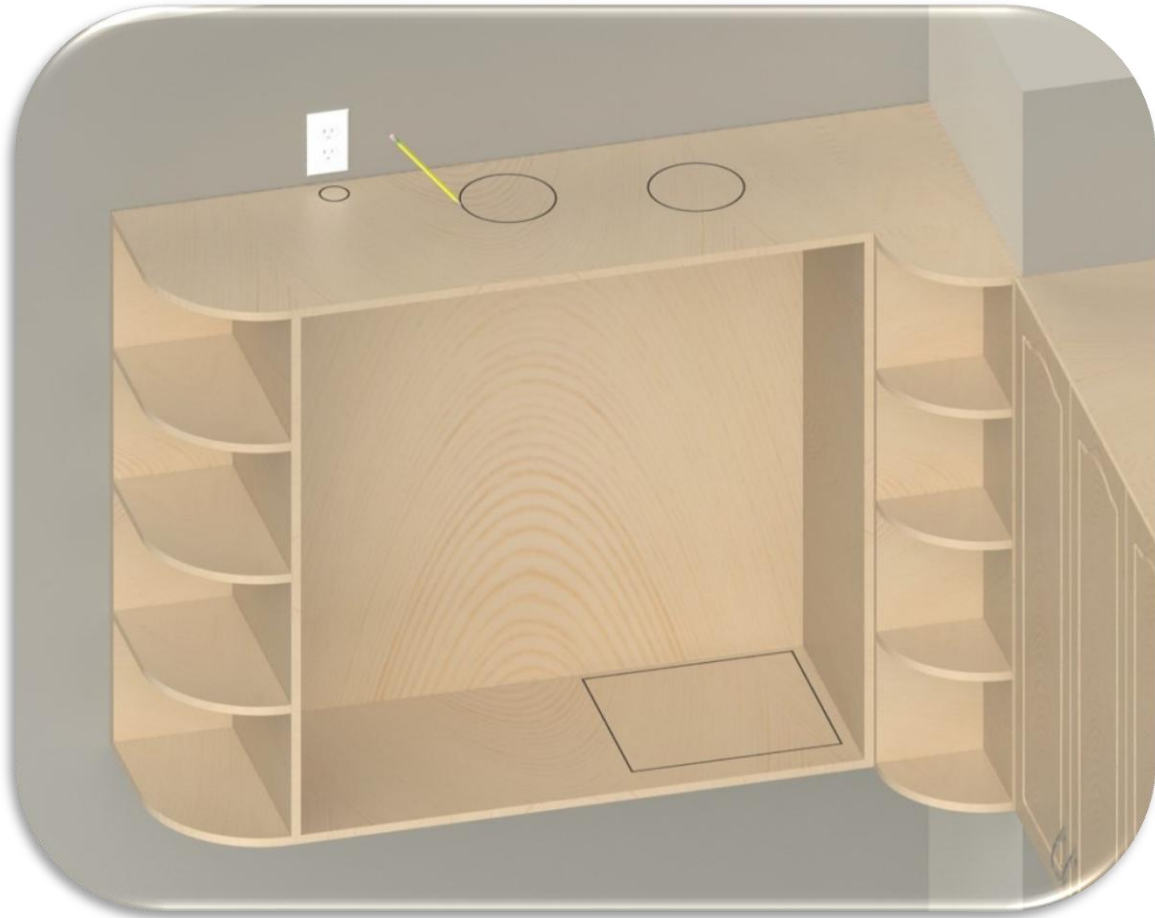

Step 1

- Modify the Custom cabinet to accommodate the Plus Cabinet. Using the provided drawings in Section 7, use appropriate tooling to remove the necessary material from the cabinet.

5.4 Plus Jet Pack Installation



Step 2

- If possible, provide the Installation spec to the cabinet maker ahead of build. Please reference Section 7 for Engineering Prints.

5.5 Plus Jet Pack Installation



Step 3

- Locate the Plus Cabinet into the custom cabinet with the Plus Cabinet oriented to the right until it sits flush with the right side face of the custom cabinet.

5.6 Plus Jet Pack Installation

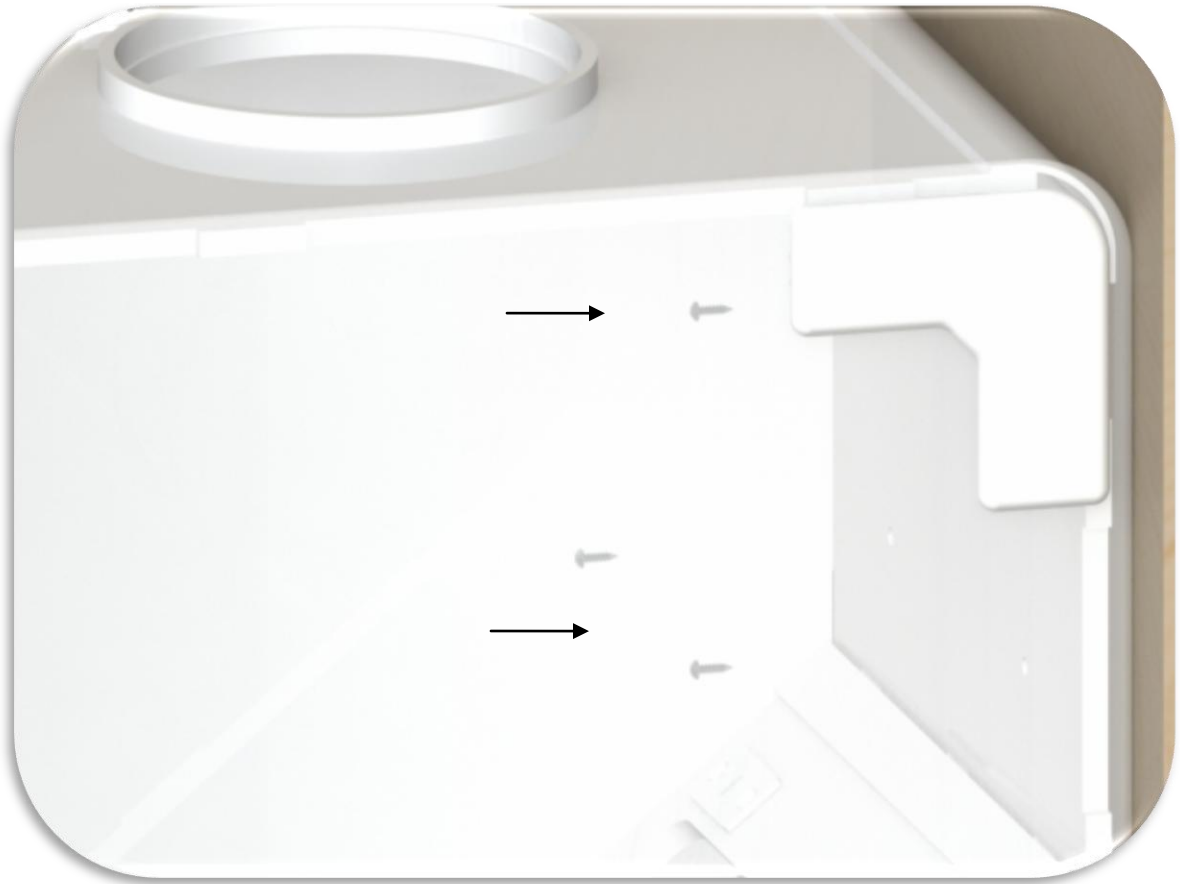

Step 4

- Using a level ensure that the Plus Cabinet is level and to the back and right of the cabinet. In 4 places using provided hardware, set the 4 set screws that fix the right face of the Plus Cabinet to the custom cabinet. (Note, this area is only accessible from the bottom right chute access)

5.7 Plus Jet Pack Installation

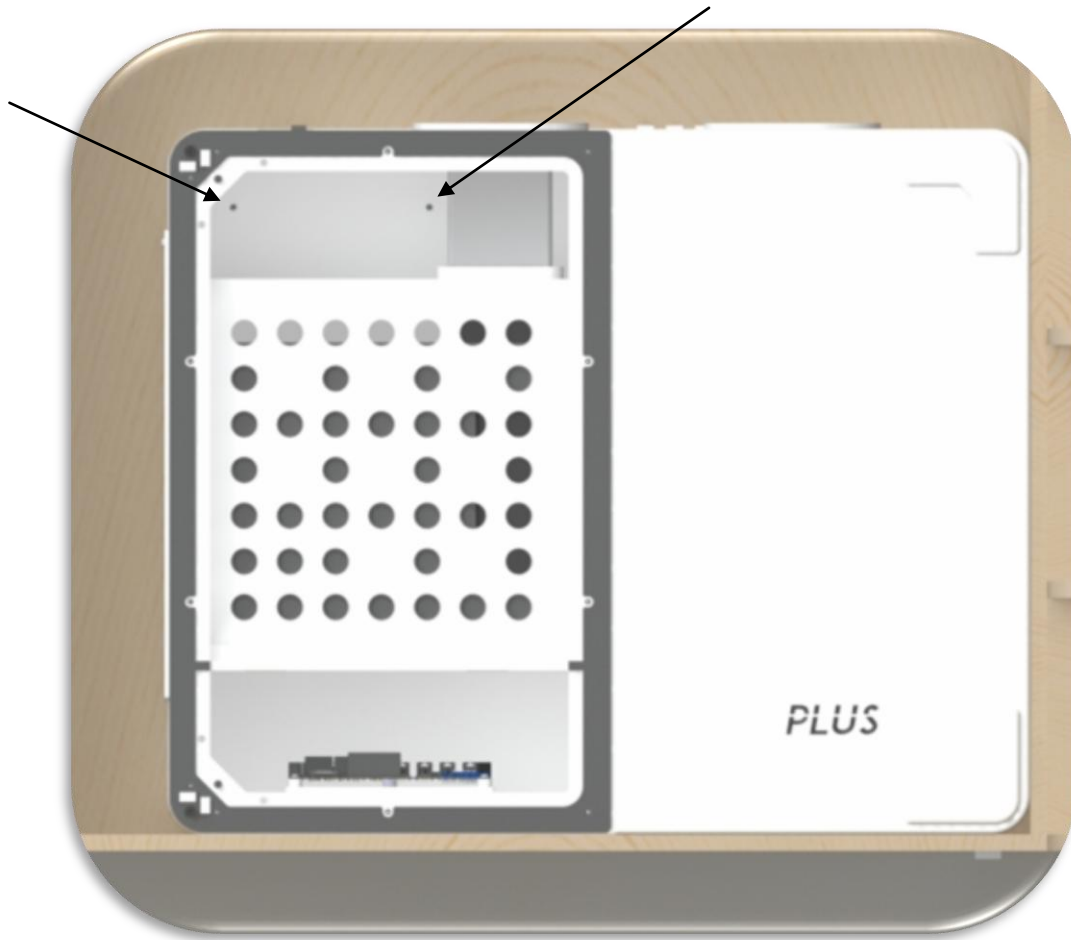

Step 5

- Set 2 set screws through the back wall of the Plus Cabinet into the custom cabinet.

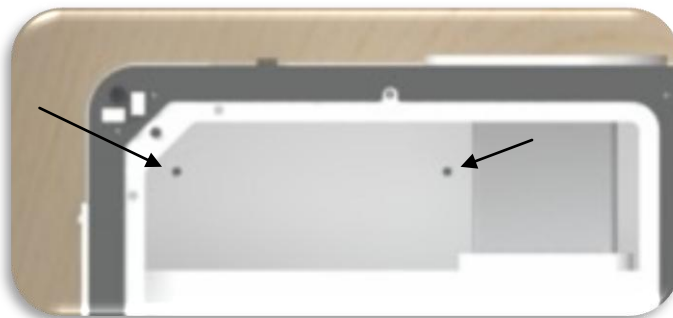

5.8 Plus Jet Pack Installation

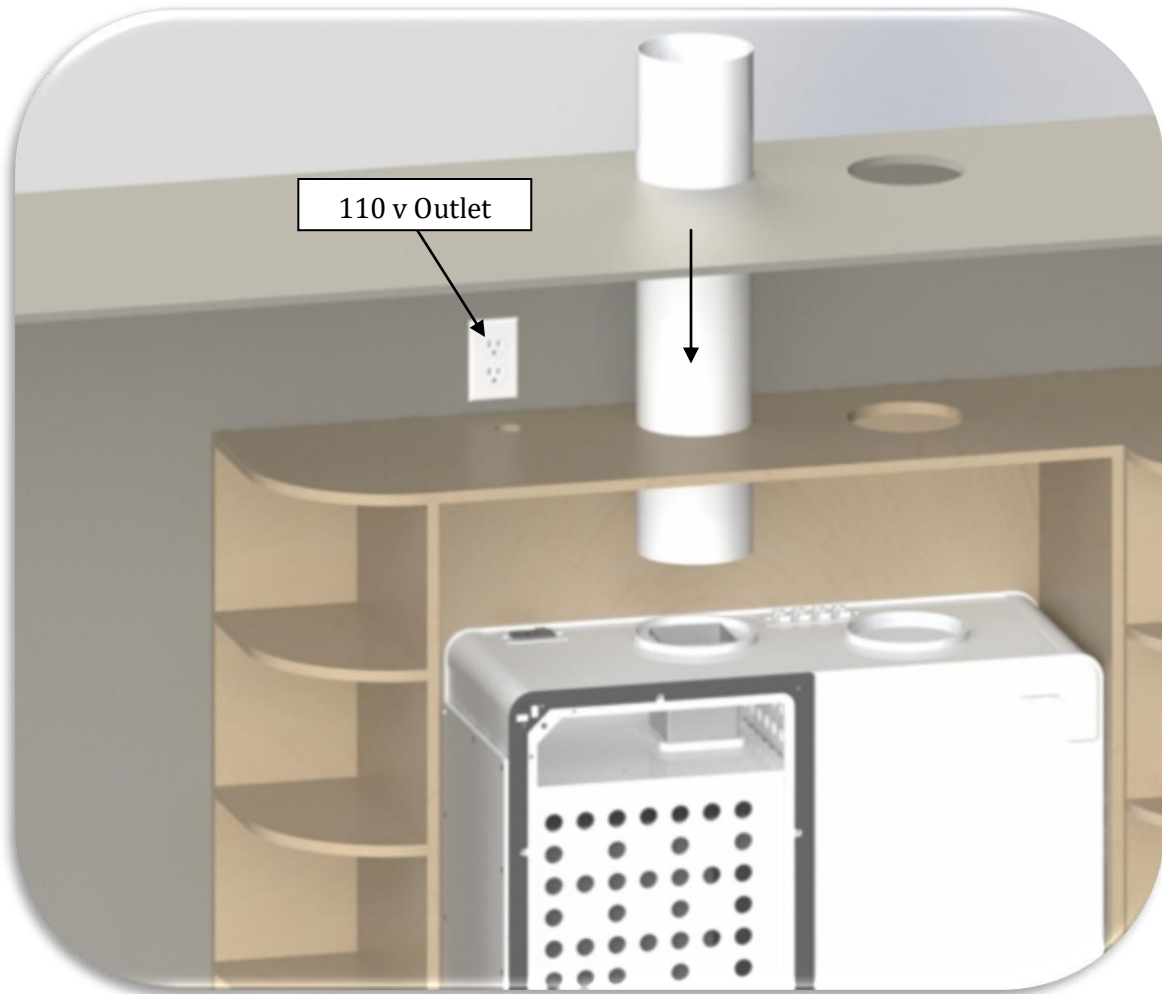

Step 6

- Cut out a section of 6" SDR 35 pipe so that it sits either flush or above the top of the cabinet or extends through the ceiling. Use a window sealer to seal between the pipe penetration and the custom cabinet.

5.9 Plus Jet Pack Installation



Step 7

- Connect the trunk line to the Vac Chamber flange. Bond in place ensuring a tight supply seal.

5.10 Plus Jet Pack Installation



Step 8

- Attach main front panel. Prior to attaching the panel, make sure the seal material is in good shape and has not been pulled off or torn during the installation process. Attach panel using the provided hardware. Reinstall the two magnetic cover plates.

5.11 Plus Jet Pack Installation

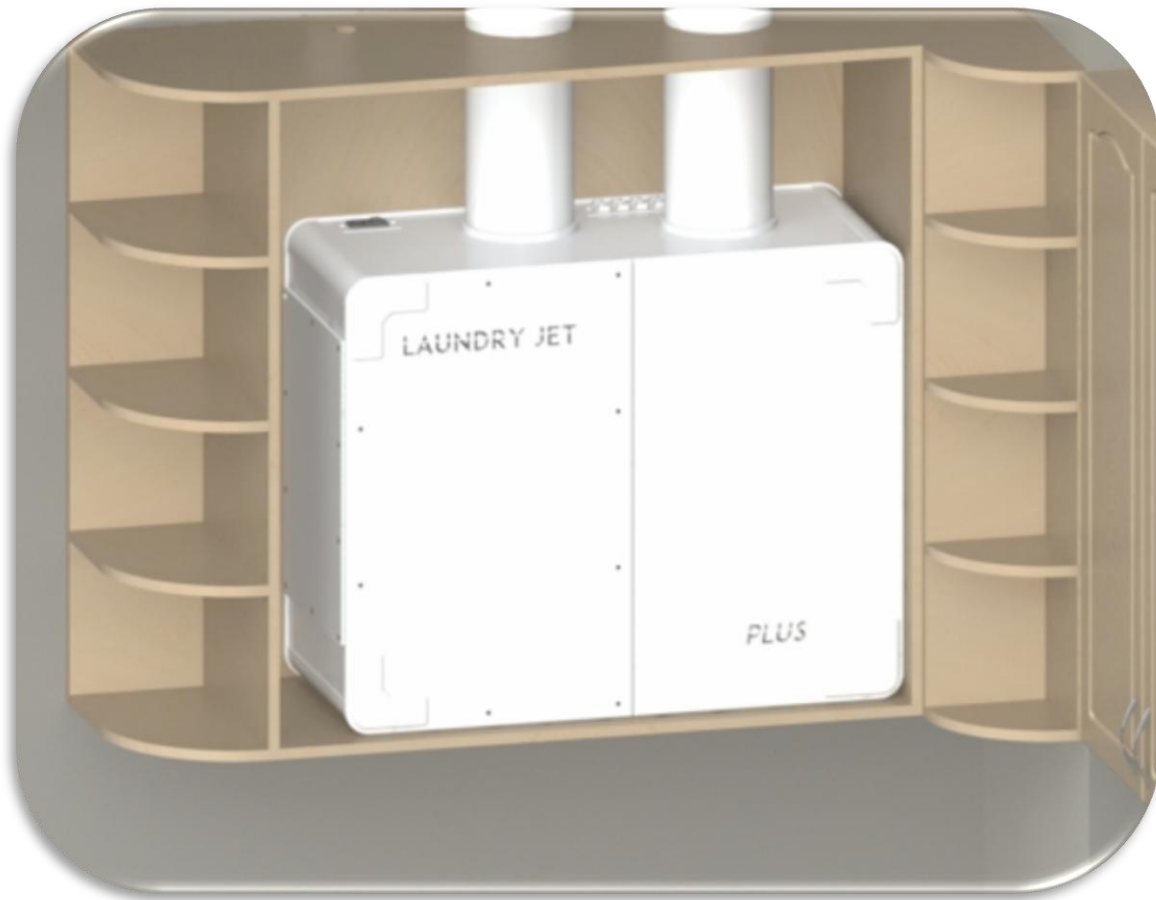

Step 9

- Test the discharge port door. Make sure that the door moves freely without drag as it cycles open and close.
- Open & close cabinet doors to make sure they have adequate clearance to open and close freely. There is no need for a seal here as the Plus Cabinet is a sealed system.

5.12 Plus Jet Pack Installation

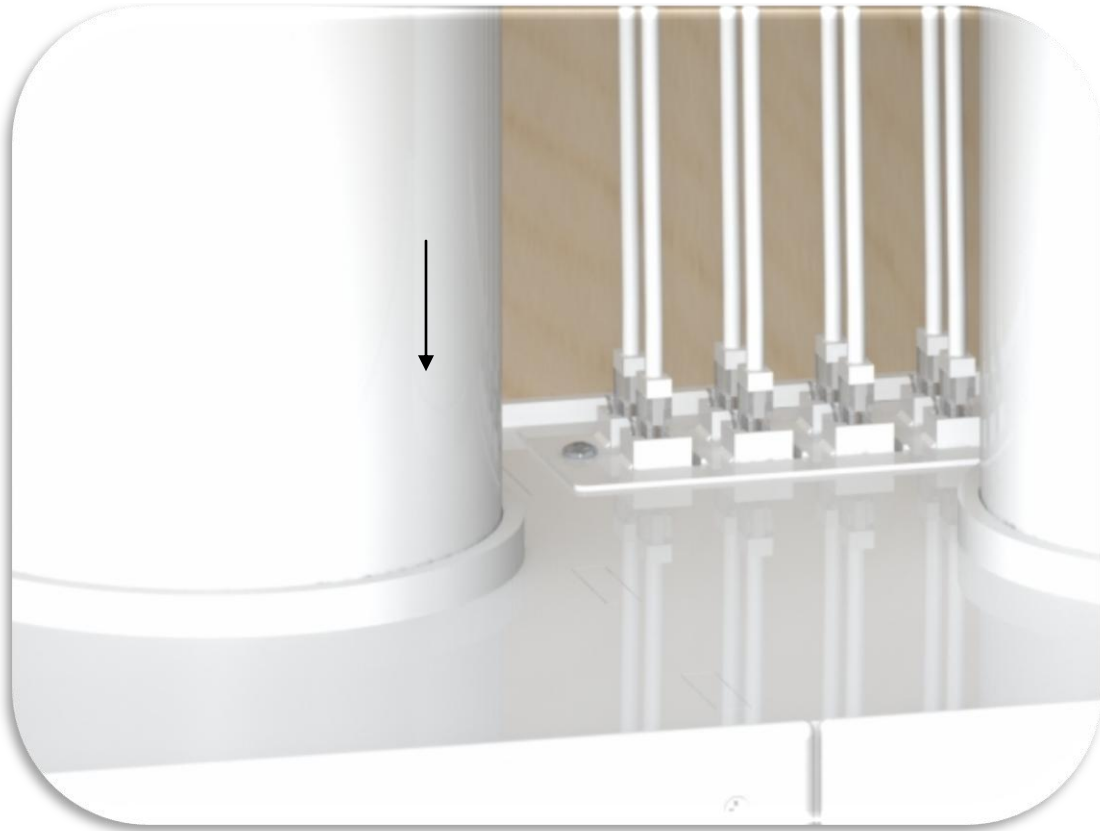

Step 10

- Test all RJ45 connections prior to the next step (T568B)
- Ensure that the Jet Pack is not plugged in.
- Connect all the RJ45 cables as shown above.
- Make sure all ISlide Ports are fitted and properly connected and ready to run
- Plug in your Jet Pack unit to the appropriate power supply
- Proceed to verify proper operation of ISlide ports

6 Warranty

Lifetime Limited Warranty

Laundry Jet is protected by a 3 year limited lifetime warranty. This warranty is valid from the date of purchase, for as long as you are the original owner, the system remains at its original place of installation and as long as the warranty form has been completed and submitted on our website: <http://www.laundryjet.com/warranty>

- Metal body of the Laundry Jet Units.
- Laundry Jet Posiflo Power unit • Ports
- Digital Control Board

THIS IS THE SOLE AND EXCLUSIVE WARRANTY OF LIFE FLOW LLC – LAUNDRY JET. IMPLIED WARRANTIES, INCLUDING IMPLIED WARRANTIES OF MERCHANTABILITY OR FITNESS FOR A PARTICULAR PURPOSE ARE LIMITED IN DURATION OF LIMITED WARRANTY PERIOD.

Should any defect in material or workmanship appear within the time of the above warranty, the selling Laundry Jet Dealer should be contacted in the first instance. The Dealer shall repair or replace (at Laundry Jet's sole option), or credit, such part or parts in accordance with the applicable warranty period stated above. Lifeflow, LLC – Laundry Jet shall not be responsible for such service unless provided by an authorized Laundry Jet Dealer utilizing authentic Laundry Jet replacement parts.

This warranty does not apply to loss or damage resulting from (at Laundry Jet's sole discretion) normal wear and tear, vacuum of drywall dust, neglect, abuse acts of God, accidents, improper installation, improper modification or alteration, improper use and operation or failure to provide proper maintenance.

Some countries, states or provinces do not allow exclusion of warranties or limitations of damages, so the above limitations and exclusions may not apply to you. This warranty gives you specific legal rights. You may have additional rights, which vary from State to State, or Province to Province. This limited warranty applies to USA and Canada installations only. For specific warranty information for your Country, consult your authorized Laundry Jet Dealer.

Other warranties apply to other parts of this equipment and optional accessories. Please contact the material accompanying the individual items.

LIFEFLOW, LLC – LAUNDRY JET, SHALL NOT BE RESPONSIBLE FOR ANY CONSEQUENTIAL, INCIDENTAL, OR SPECIAL DAMAGES ARISING FROM THE USE OF THIS SYSTEM.

Extended warranties are available at the time of purchase



Orientation of all cutouts originate from inside right wall of cabinet. Insert Jet Pack is mounted flush with the right wall and back wall of cabinet.

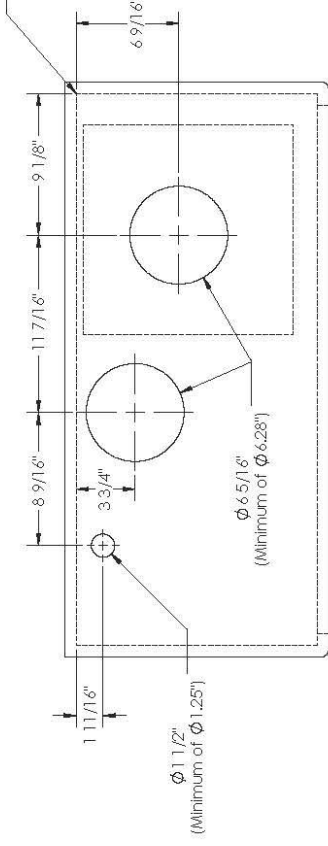

Cabinet Cutout Detail

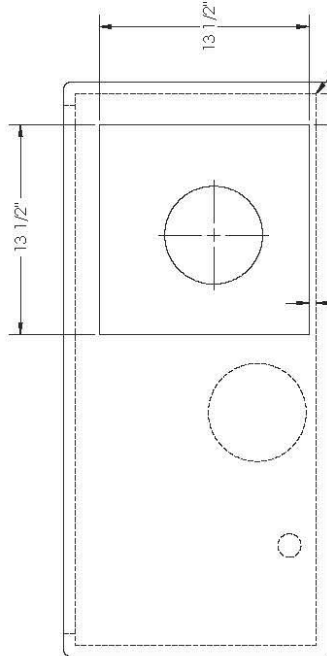
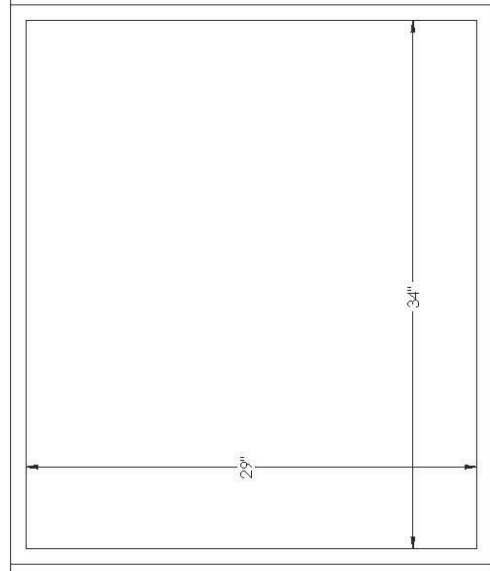
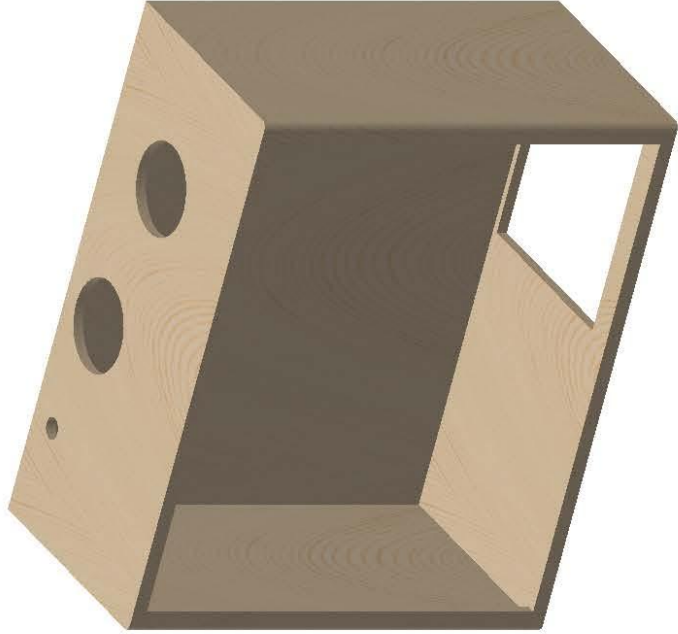

Orientation of all cutouts originate from inside right wall of cabinet. Insert Jet Pack is mounted flush with the right wall and back wall of cabinet.

UNLESS OTHERWISE SPECIFIED:		NAME	DATE
DIMENSIONS ARE IN INCHES	DRAWN	CW	3.24.22
TOLERANCES:	CHECKED	DH	3.24.22
FRACTIONAL: ±	ENG. APPR.	DH	3.24.22
DECIMAL: ±	MFG. APPR.		
TWO PLACE DECIMAL ±	Q.A.		
THREE PLACE DECIMAL ±	CUSTOMER:		
	MATERIAL		
	FINISH		
	DO NOT SCALE DRAWING		

LAUNDRY JET		TITLE: Plus Insert Jet Pack Engineering Prints	
SIZE	DWG. NO.	REV	
A	PIJP-SHEET1	8	
SCALE: 1:6	WEIGHT:	SHEET1 OF 4	

PROPRIETARY AND CONFIDENTIAL
 THE INFORMATION CONTAINED IN THIS DRAWING IS THE SOLE PROPERTY OF LAUNDRY JET. IT IS TO BE KEPT IN FACTORY AND A WHOLE WITHOUT THE WRITTEN PERMISSION OF LAUNDRY JET IS PROHIBITED.

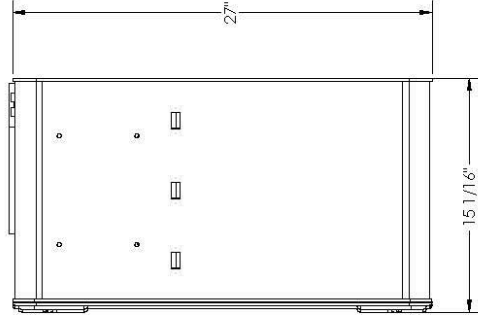
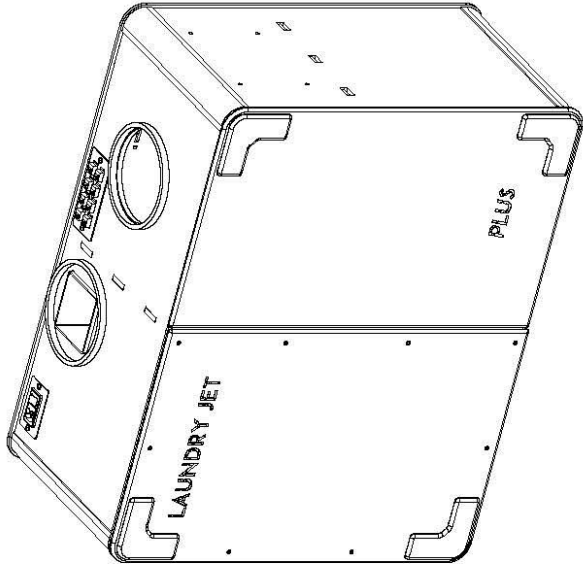
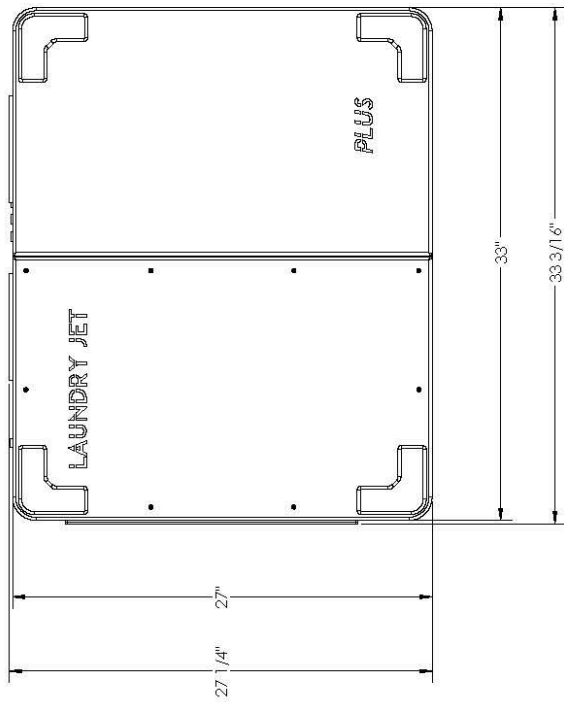
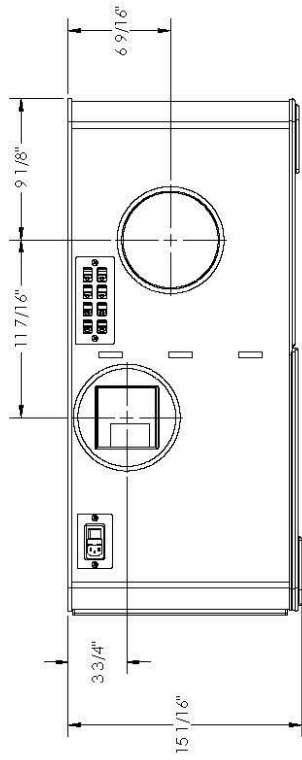

UNLESS OTHERWISE SPECIFIED:
 DIMENSIONS ARE IN INCHES
 TOLERANCES:
 FRACTIONAL: ±0.005
 DECIMAL: ±0.005
 BEND: ±0.010
 TWO PLACE DECIMAL: ±0.010
 THREE PLACE DECIMAL: ±0.005

NAME	DATE
DRAWN CW	3,24,22
CHECKED DH	3,24,22
ENG. APPR. DH	3,24,22
MFG. APPR.	
Q.A.	
CUSTOMER:	

PROPRIETARY AND CONFIDENTIAL
 THE INFORMATION CONTAINED IN THIS DRAWING IS THE SOLE PROPERTY OF LAUNDRY JET. IT IS TO BE USED ONLY IN ACCORDANCE WITH THE WRITTEN PERMISSION OF LAUNDRY JET. PERMISSION OF LAUNDRY JET IS PROHIBITED.

LAUNDRY JET		Plus Insert Jet Pack Engineering Prints	
SIZE	DWG. NO.	REV	
A	PIJP-SHEET2	8	
SCALE: 1:6	WEIGHT:	SHEET 2 OF 4	

Plus Insert Cabinet Detail

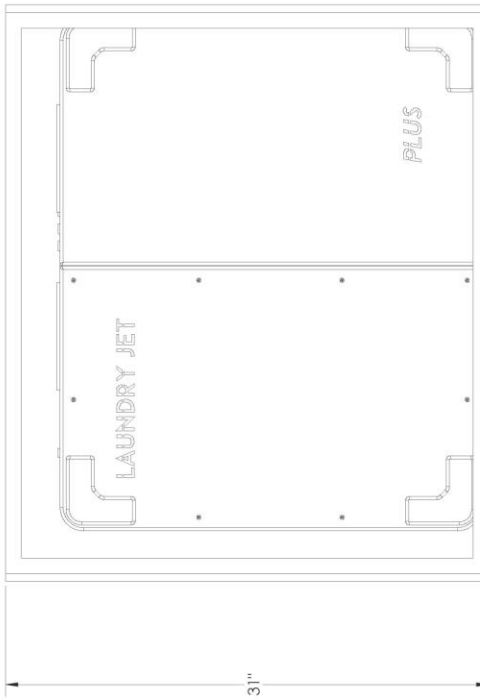
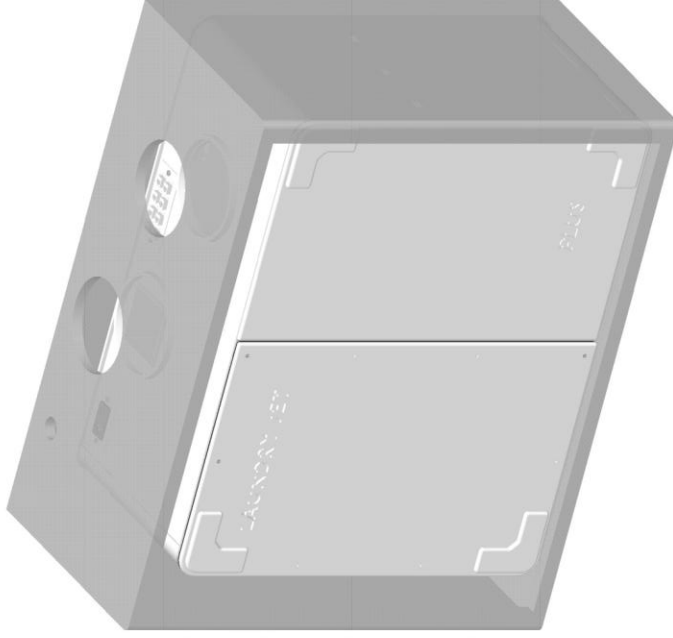
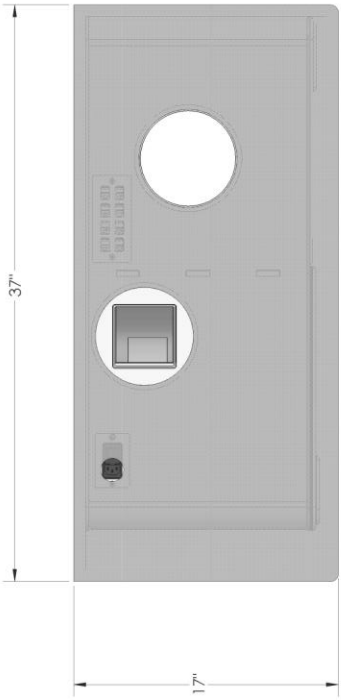

UNLESS OTHERWISE SPECIFIED:

DIMENSIONS ARE IN INCHES
TOLERANCES:
FRACTIONAL: ±.04, ±.01 BEND: ±.01
DECIMAL: TWO PLACE DECIMAL
THREE PLACE DECIMAL

MATERIAL:
FINISH:
DO NOT SCALE DRAWING

PROPRIETARY AND CONFIDENTIAL
THE INFORMATION CONTAINED IN THIS DRAWING IS THE SOLE PROPERTY OF LAUNDRY JET. ANY REPRODUCTION, PARTIAL OR COMPLETE, WITHOUT THE WRITTEN PERMISSION OF LAUNDRY JET IS PROHIBITED.

NAME	DATE
DRAWN CW	3.24.22
CHECKED DH	3.24.22
ENG APPR. DH	3.24.22
MFG APPR.	
Q.A.	
CUSTOMER:	

LAUNDRY JET

**Plus Insert Jet Pack
Engineering Prints**

SIZE	DWG. NO.	REV
A	PUP-SHEET3	8
SCALE: 1:6	WEIGHT:	SHEET 3 OF 4

Defined Spacing is minimum requirement for insertion of the insert Jet Pack Assembly. It is recommended that additional spacing be allowed for easy installation where possible.

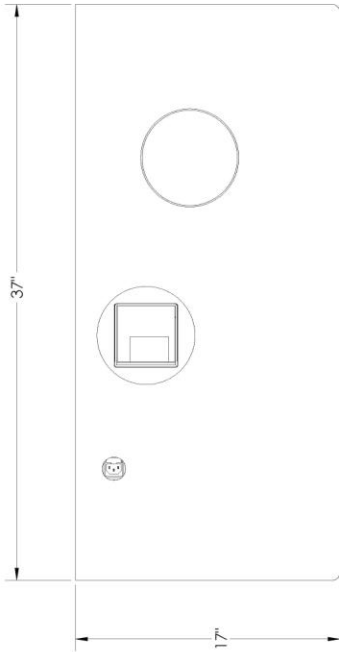

Plus Insert Cabinet Detail

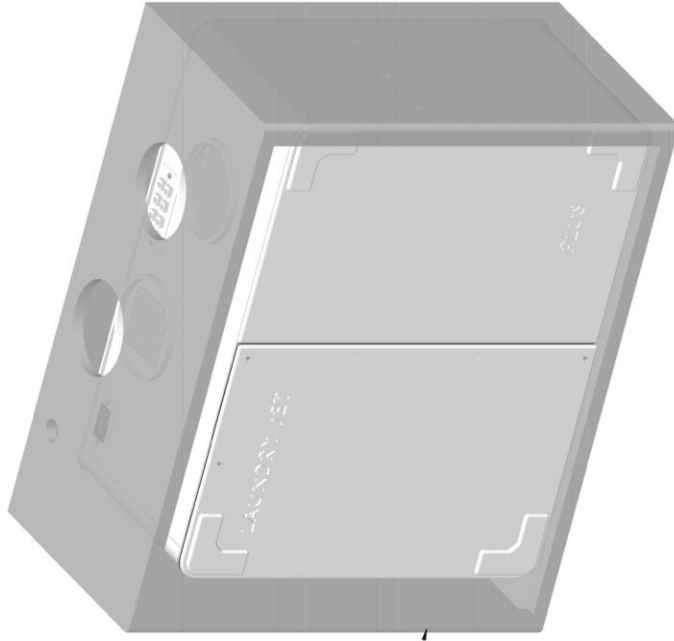

Cabinet can be finished using a typical single door or double door styles.

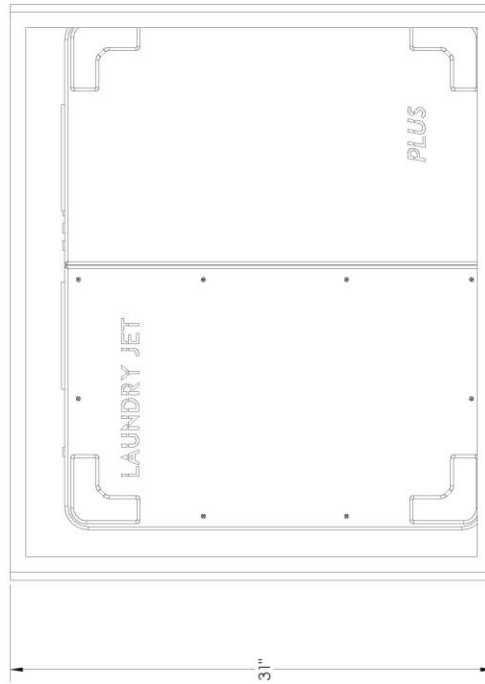

UNLESS OTHERWISE SPECIFIED:
 DIMENSIONS ARE IN INCHES
 TOLERANCES:
 FRACTIONAL: ±0.005
 DECIMAL: ±0.005
 ANGLES: ±0.005
 HOLE: ±0.005
 BEND: ±0.005
 TWO PLACE DECIMAL: ±0.01
 THREE PLACE DECIMAL: ±0.005

PROPRIETARY AND CONFIDENTIAL
 THE INFORMATION CONTAINED IN THIS DRAWING IS THE SOLE PROPERTY OF LAUNDRY JET. ANY REPRODUCTION, PARTIAL OR COMPLETE, WITHOUT THE WRITTEN PERMISSION OF LAUNDRY JET IS PROHIBITED.

NAME	DATE
DRAWN CW	3.24.22
CHECKED DH	3.24.22
ENG APPR. DH	3.24.22
MFG APPR.	
Q.A.	
CUSTOMER:	

SIZE	DWG. NO.	REV
A	PUP-SHEET4	8
SCALE: 1:6	WEIGHT:	SHEET 4 OF 4

LAUNDRY JET

Plus Insert Jet Pack Engineering Prints

TITLE:
Plus Insert Jet Pack Engineering Prints